

SIMPSON**Strong-Tie**

Utspikning



REV

0

REV DATE

24/10/25

DWG NAME

C_BTALU1200-200_2D0_NP_JTP-SE

Art. Nr.

=

BTALU1200/200

Fästelement

=

Trä till trä

Balk på stolpe

Typ av infästning

=

Delvis utspikning

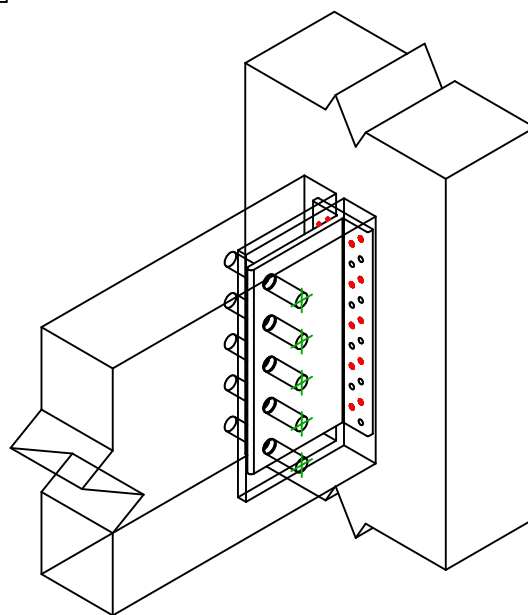
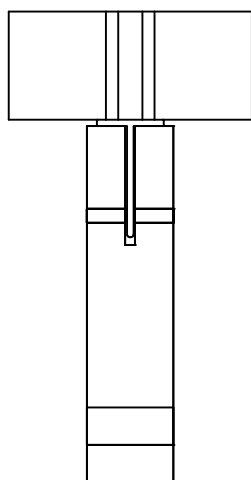
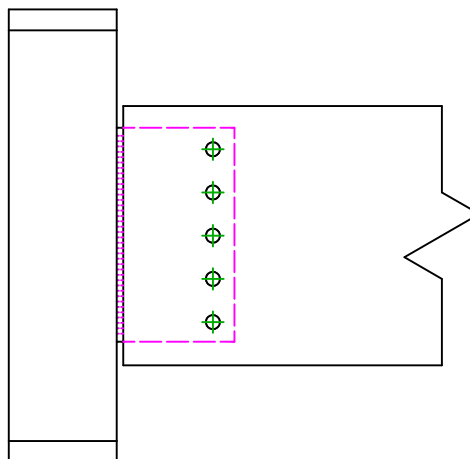
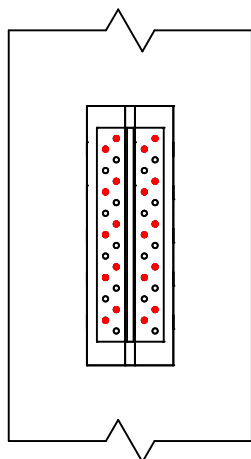
Infästning i
huvudbalk

Symbol



Fästelement

CNA  

Art. Nr.

CNA4.0X50

CSA  

Art. Nr.

CSA5.0X35/40

-

-

Antal

20

Fästelement i
sekundärbalk

Symbol



Fästelement

SDD  

Art. Nr.

SDD7.5

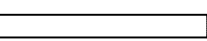
STD  

Art. Nr.

STD12

Antal

5